

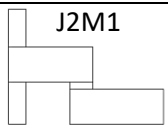

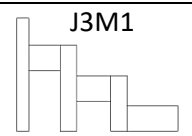



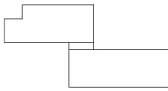
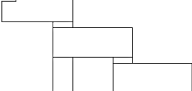
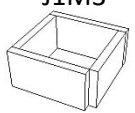
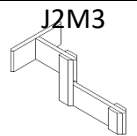
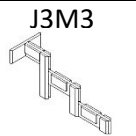
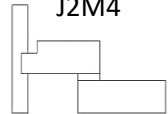
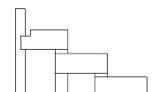
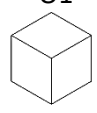

Guide de Montage Escalier Panoramique

La partie de la terrasse sans escalier panoramique est montée conformément au guide de montage général. Le ½ portique de fin et le portique de jonction (entre garde-corps et escalier panoramique) ne sont pas coupés d'origine, ceci afin de pouvoir installer l'escalier panoramique à droite ou à gauche.

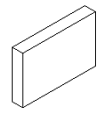
Liste des éléments :

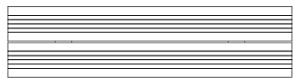
	1 marche	2 marches	3 marches
Limon intermédiaire de façade	J1M1 	J2M1 	J3M1 
Limon entaillé	J1M2 	J2M2 	J3M2 
Kit limon d'angle	J1M3 	J2M3 	J3M3 
Limon intermédiaire de côté		J2M4 	J3M4 
Cale pour contremarche		O1 	
Cale pour limon retour d'angle		O2 	
Cale limon d'angle		O3 	
Marches d'angle		IP 1 à IP 6 	
Marche retour		IP 7 et IP 8 	
Marche façade		IP 9 et IP 10 	

1. Positionnement du ½ portique de fin :

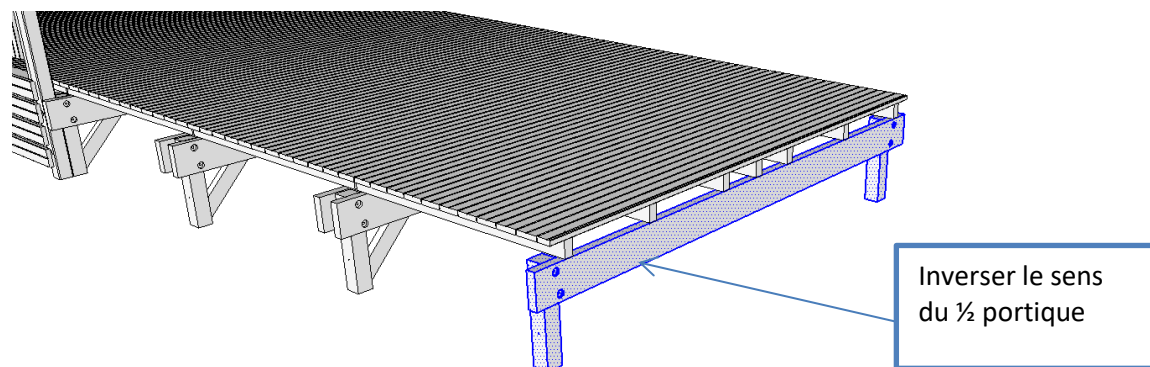

2. Réduction des portiques et ½ portique :

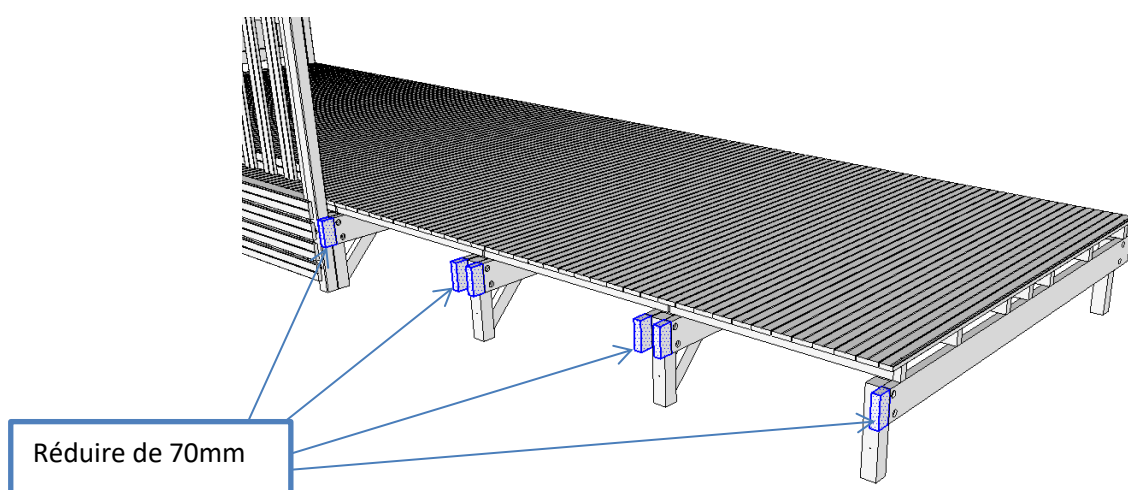

3. Pose de la cale O2 (1 vis 5x70) et du potelet D4 (1 vis 5x90) :

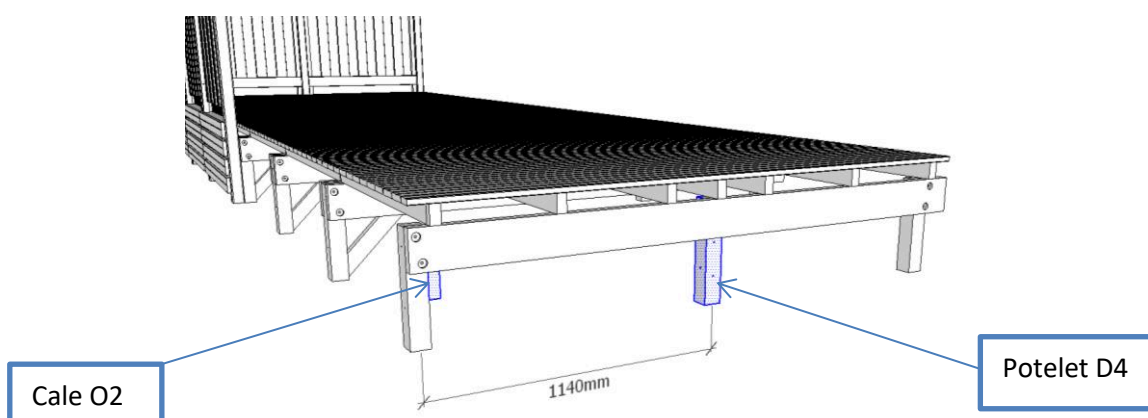

4. Pose des limons entaillés (1 vis 5x90 par limon) :

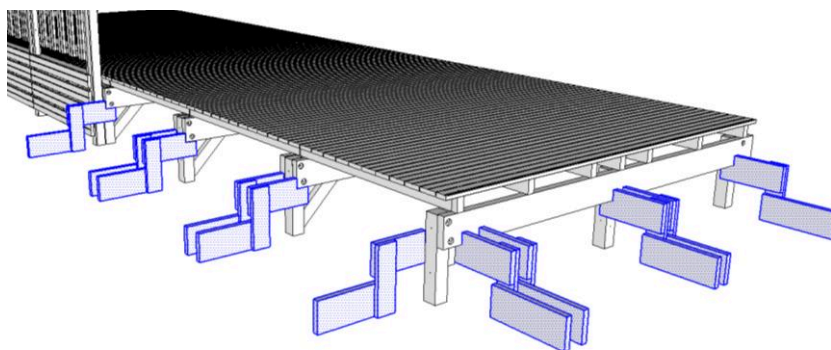

5. Pose des limons intermédiaires de façade (1 vis 5x90 par limon):

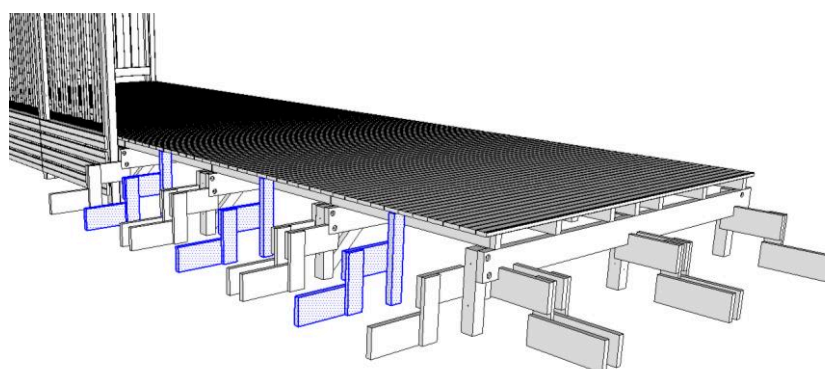

6. Pose des limons intermédiaires de côté (1 vis 5x90 par limon):

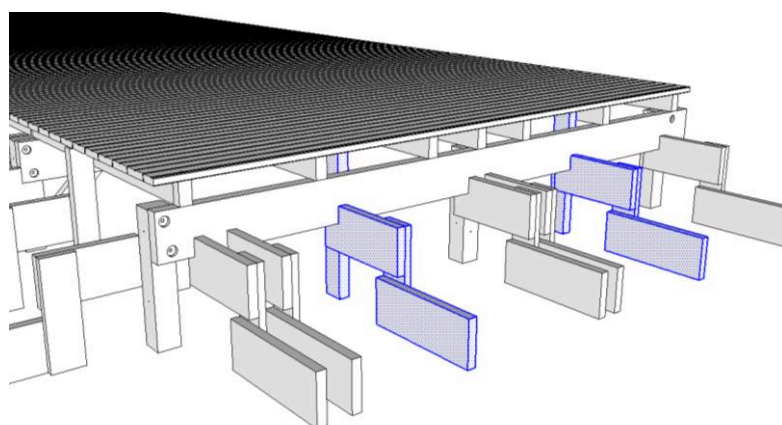

7. Pose du limon d'angle (4 vis 4x40):

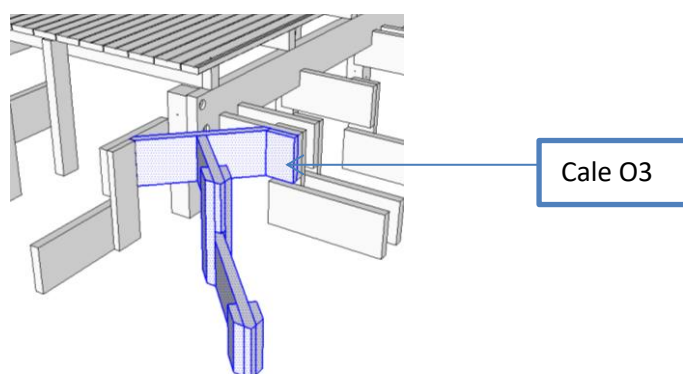

8. Pose des marches d'angle (vis 5x70) :

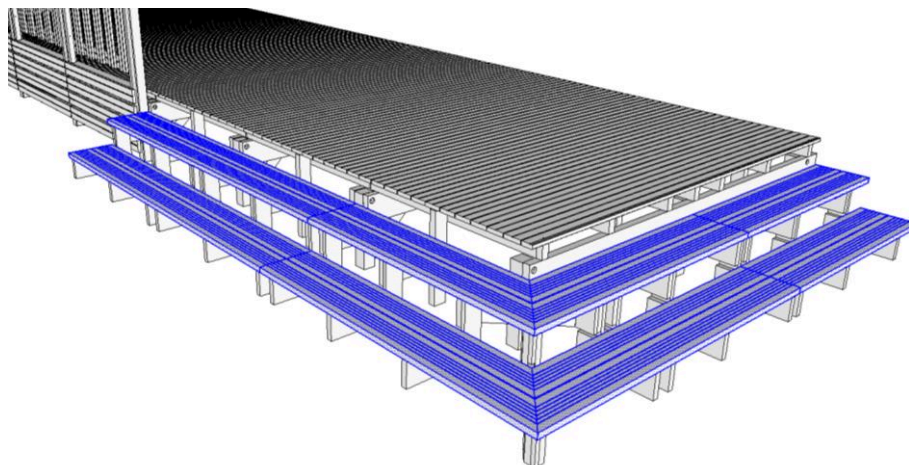

9. Pose des cales O1 (1 vis 5x90 par cale):

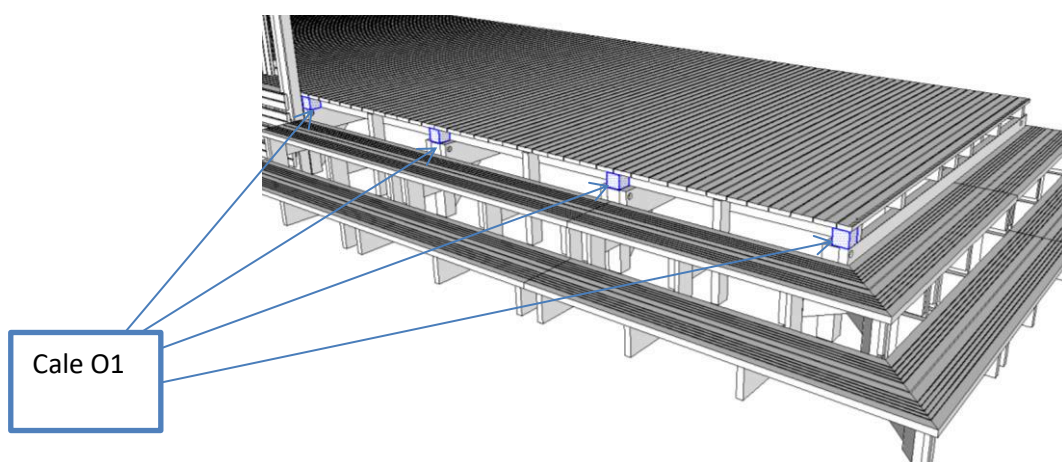

10. Pose des contremarches (vis 4x40) :

